

TRADITIONAL
GAS FIREPLACES



www.regency-fire.com



TRADITIONAL
GAS FIREPLACES

WHY CHOOSE REGENCY?

BEAUTIFUL HOME HEATING SOLUTIONS

Regency Fireplace Products was founded over 35 years ago with a mission to produce the finest fireplace products available anywhere. Regency provides heating solutions for every room in your home. Listening to our customers has enabled us to become the premium brand in the market today.

REGENCY QUALITY

The Regency name means quality in every way. The product is created and built in a world class manufacturing facility focused on getting every detail just right. Represented across North America by a carefully selected professional retail network, you can rely on knowledgeable dealers and installers who understand how to make our products run safely and to the optimum performance.

EXCEPTIONAL FIRE

The essence of each and every Regency fireplace is the unique flame. Without question, it's the best in the industry. With its dancing flames and glowing embers, the Regency fire looks just like a wood fire.

CUSTOM STYLING

By researching current trends and styles we have created tasteful options and accessories that allow you to tailor the look of our fireplace to your home. Sleek and simple or grand and glamorous... your choice.

LIFETIME GUARANTEE

I am so confident in the quality workmanship, the finest materials and durable heavy-duty construction invested in each and every product, that I offer a Limited Lifetime Warranty. The Regency warranty is the best in the industry. I am absolutely sure that you will be as proud of your Regency Gas Fireplace as I am – I guarantee it.



Robert Little
Founder & CEO



TABLE OF CONTENTS

Bellavista® Gas Fireplaces

B41XTCE, B41XTE 04

B36XTCE, B36XTE 06

Regency Panorama® Gas Fireplaces

P36, P36E, P36D 08

P33, P33E, P33CE 10

P131, P121 12

Excalibur & Liberty Gas Fireplaces

P90 14

L965E 15

Design Choices & Options 16

Technical Specs 20





Bellavista B41XTCE with old town red brick panels and integrated safety screen.

BELLAVISTA® LARGE GAS FIREPLACES | B41XTCE & B41XTE



B41XTE - Vignette Faceplate - Black



B41XTE - Vignette Faceplate - Tuscan Sunset



B41XTE - Vignette Faceplate - Platinum

EXPANSIVE VIEWING AREA

With its impressive viewing area and artistic fire presentation, the Bellavista® creates beautiful gathering spaces. The B41XTCE offers a flush face design for a frameless display, while the B41XTE offers a range of trim finishes to suit any environment.

EXCEPTIONAL FLAME

Platinum embers and finely detailed logs molded from real wood create a truly authentic fire experience. With 42,500 BTUs of controllable heat, the Bellavista is an efficient direct vent fireplace perfect for medium to large living spaces.

SPECIFICATIONS (NATURAL GAS)*	B41XTCE	B41XTE
Input (BTU)	42,500	42,500
Turn down to (BTU)	30,000	30,000
EnerGuide Rating (Canada only)	68.59%	68.59%
Efficiency (steady state)	73%	73%

DIMENSIONS (FINISHED AREA)		
Viewing Area	840 sq. in.	840 sq. in.
Width	38-7/16"	41-11/16"
Height	29-1/8"	36-11/16"
Depth	25-9/16"	22-3/8"

* For propane (LP) specs please see page 20.
For detailed specifications please see pages 20-23.



Bellavista B41XTE shown with Vignette faceplate in Tuscan Sunset, rustic brown brick panels and integrated safety screen.



B41XTE - Vignette Faceplate - Black Chrome



*B41XTE - Vignette Faceplate - Black
Vignette Door Inlay - Black*



*B41XTE - Vignette Faceplate - Black
Vignette Door Inlay - Tuscan Sunset*

STANDARD FEATURES

- Natural gas or propane
- Safety screen
- Ceramic glass
- Log set with embers
- Fire grate
- Flame height adjustment control
- Proflame remote control
- Electronic ignition with SureFire™ switch
- Top or rear vent for versatile installations
- Limited lifetime warranty

OPTIONS

- Vignette surrounds in various colors**
- Vignette door inlays in various colors**
- Vignette finishing trim**
- Brick panels in a variety of colors and designs
- Inner reflective panels in black enamel
- Accent light
- Flush panels & mesh guard**
- Ember upgrade kit
- Wall thermostat
- Variable speed blower
- Vertical or horizontal vent terminations
- AstroCap® venting system

***B41XTE only*



Bellavista B36XTCE shown with rustic brown brick panels and integrated safety screen.

BELLAVISTA® MEDIUM GAS FIREPLACES | B36XTCE & B36XTE



B36XTE - Vignette Faceplate - Black



B36XTE - Vignette Faceplate - Tuscan Sunset



B36XTE - Flush panels

BEAUTIFUL FLAMES

Bellavista means beautiful view in Italian. This is a perfect description of the fire view from the most popular sized fireplaces in the Regency line up.

BOLD STYLE

The B36XTCE and B36XTE models feature a bold flame and log package behind a 652 square inch viewing area providing up to 31,000 BTU of comforting heat. The quality workmanship is evident in the fine finishes, custom accessories and high safety ceramic glass.

SPECIFICATIONS (NATURAL GAS)*	B36XTCE	B36XTE
Input (BTU)	31,000	31,000
Turn down to (BTU)	21,500	21,500
EnerGuide Rating (Canada only)	66.5%	66.5%
Efficiency (steady state)	71%	71%

DIMENSIONS (FINISHED AREA)		
Viewing Area	652 sq.in.	652 sq.in.
Width	32-7/8"	36"
Height	25-5/8"	35-1/4"
Depth	23-5/8"	17-5/16"

* For propane (LP) specs please see page 20.
For detailed specifications please see pages 20-23.



Bellavista B36XTE shown with Vignette faceplate in platinum, Vignette finishing trim and integrated safety screen.



B36XTE - Vignette Faceplate - Black Chrome



*B36XTE - Vignette Faceplate - Black
Vignette Door Inlay - Tuscan Sunset*



*B36XTE - Vignette Faceplate - Black
Vignette Door Inlay - Black*

STANDARD FEATURES

- Natural gas
- Safety screen
- Ceramic glass
- Log set with embers
- Fire grate
- Flame height adjustment control
- Proflame remote control
- Electronic ignition with SureFire™ switch
- Top or rear vent for versatile installations
- Limited lifetime warranty

OPTIONS

- Vignette surrounds in various colors**
- Vignette door inlays in various colors**
- Vignette finishing trim**
- Brick panels in a variety of colors and designs
- Inner reflective panels in black enamel
- Accent light
- Ember upgrade kit**
- Flush panels & mesh guard**
- Variable speed blower
- Wall thermostat
- Propane conversion kit
- Vertical or horizontal vent terminations
- AstroCap® venting system

***B36XTE only*



Panorama® P36 shown with Vignette faceplate in black, Vignette finishing trim, rustic brown brick panels and integrated safety screen.

PANORAMA® MEDIUM GAS FIREPLACES | P36/P36E/P36D



Black Louvers



Vignette Faceplate - Tuscan Sunset



Vignette Faceplate - Platinum

POPULAR SIZE

The most popular fireplace size is available in both slim and deep box designs, delivering a beautiful fire and efficient heat to most common family rooms, dens and bedrooms.

VERSATILE STYLE

With the versatile Panorama P36, you can turn a traditional fireplace into a dynamic part of your home decor. Customize with warm finishes, screen doors and decorative accents - make it your Regency, right down to the last detail.

SPECIFICATIONS (NATURAL GAS)*	P36	P36E	P36D
Input (BTU)	30,000	29,500	30,000
Turn down to (BTU)	15,500	19,500	15,500
EnerGuide Rating (Canada only)	62.70%	67.45%	64.6%
Efficiency (steady state)	82%	82%	82%

DIMENSIONS (FINISHED AREA)	P36	P36E	P36D
Viewing Area	452 sq.in.	452 sq.in.	452 sq.in.
Width	36"	36"	36"
Height	30-1/2"	30-1/2"	30-1/2"
Depth	12-3/4"	12-3/4"	17-1/8"

* For propane (LP) specs please see page 20.
For detailed specifications please see pages 20-23.



P36 shown with Vignette faceplate in black chrome, Vignette finishing trim, rustic brown brick panels and integrated safety screen.



*Vignette Faceplate - Black
Vignette Door Inlay - Black*



*Vignette Faceplate - Black
Vignette Door Inlay - Black Chrome*



*Vignette Faceplate - Black
Vignette Door Inlay - Tuscan Sunset*

STANDARD FEATURES

- Natural gas
- Safety screen
- Ceramic glass
- Log set with embers
- Fire grate
- Flame height adjustment control
- Proflame remote control
- Electronic ignition with Surefire™ switch (P36E)
- Direct spark ignition (P36/P36D)
- Limited lifetime warranty

OPTIONS

- Vignette surrounds in various colors
- Vignette door inlays in various colors
- Vignette finishing trim
- Brick panels in a variety of colors and designs
- Inner reflective panels in black enamel
- Ember upgrade kit
- Black louvers & mesh guard
- Variable speed blower
- Wall thermostat
- Propane conversion kit
- Vertical or horizontal vent terminations
- Heat Wave™ power duct kit
- Heat Release™ kit
- AstroCap® venting system



Panorama® P36 shown with Vignette faceplate in black, Vignette finishing trim, rustic brown brick panels and integrated safety screen.

PANORAMA® SMALL GAS FIREPLACES | P33/P33E/P33CE



P33CE - Verona Surround - Stainless Steel



P33CE Verona Surround - Black Glass



Vignette Faceplate - Platinum

TRUE FLUSH FINISHING

True flush finishing provides an unobstructed view of the fire in Regency's Panorama™ P33CE gas fireplace. As a focal point in small to medium-sized spaces, the P33CE embodies the complete fireplace experience with a ceramic log set and glowing embers.

COMPACT DESIGN

Measuring just 12-3/4 inches in depth, the slim design of the P33 offers tall style in a compact size with all the features of the Panorama collection and just the right amount of heat output.

SPECIFICATIONS (NATURAL GAS)*	P33	P33E	P33CE
Input (BTU)	20,000	20,000	20,000
Turn down to (BTU)	14,000	14,000	14,000
EnerGuide Rating (Canada only)	65.50%	67.41%	67.41%
Efficiency (steady state)	76%	76%	76%

DIMENSIONS	P33	P33E	P33CE
Viewing Area	416 sq.in.	416 sq.in.	416 sq.in.
Width	33"	33"	34-9/16"
Height	29"	29"	29-1/4"
Depth	12-3/4"	12-3/4"	16"

* For propane (LP) specs please see page 20.
For detailed specifications please see pages 20-23.



P33 shown with Vignette faceplate in black chrome, Vignette finishing trim, rustic brown brick panels and integrated safety screen.



P33 - Vignette Faceplate - Black Chrome



*P33 - Vignette Faceplate - Black
Vignette Door Inlay - Black Chrome*



*P33 - Vignette Faceplate - Black
Vignette Door Inlay - Tuscan Sunset*

STANDARD FEATURES

- Natural gas
- Safety screen
- Ceramic glass
- Log set with embers
- Fire grate
- Flame height adjustment control
- Proflame remote control
- Direct spark ignition (P33)
- Electronic ignition with SureFire® switch (P33E/P33CE)
- 45° flue for versatile installations
- Limited lifetime warranty

OPTIONS

- Verona glass or metal surrounds in various colors (P33CE)
- Vignette surrounds in various colors (P33/P33E)
- Vignette door inlays in various colors (P33/P33E)
- Vignette finishing trim (P33/P33E)
- Black louvers (P33/P33E)
- Brick panels in various colors and designs
- Inner reflective panels in black enamel
- Ember upgrade kit
- Wall thermostat
- Variable speed blower
- Vertical or horizontal vent terminations
- Propane conversion kit
- Heat Wave™ power duct kit
- AstroCap® venting system



Panorama® P131 featuring black louvers and old town red brick panels.

PANORAMA® TWO & THREE SIDED FIREPLACES | P131 & P121

ONE FIRE, TWO ROOMS

Enjoy the ambience of a Regency fire in two rooms with a see-through direct vent fireplace. The Panorama two and three sided gas fireplaces add a stylish transition between living spaces. The large glass viewing area maximizes the radiant heat output providing up to 40,000 BTUs of heat per hour.

SPECIFICATIONS (NATURAL GAS)*	P131	P121
Input (BTU)	40,000	40,000
Turn down to (BTU)	20,500	20,500
EnerGuide Rating (Canada only)	60.66%	60.66%
Efficiency (steady state)	75%	75%

DIMENSIONS		
Viewing Area	1,658 sq.in.	1,305 sq.in.
Width	41-1/2"	43-1/2"
Height	36"	36"
Depth	25"	25"

* For propane (LP) specs please see page 20.
For detailed specifications please see pages 20-23.



P121 shown with black louvers and old town red brick panels.



P131 with black louvers and safety screen



P121 with black louvers and safety screen



P131 with black grilles

STANDARD FEATURES

- Natural Gas
- Safety screen
- Tempered glass
- Log set with embers
- Fire grate
- Old town red side brick panels
- Black brick panel floor
- Blower
- Flame height adjustment control
- Proflame remote control
- 45° flue for versatile installations
- Limited lifetime warranty

OPTIONS

- Louvers or decorative grilles
- Finishing trim (P121 only)
- Ceramic glass for bathroom installations
- Ember upgrade kit
- Wall thermostat
- Vertical or horizontal vent terminations
- Propane conversion kit
- AstroCap® venting system



Excalibur P90 shown with herringbone brick panels and double door inlay with integrated safety screen.

EXCALIBUR® GAS FIREPLACE | P90

TIMELESS ARCH DESIGN

The gentle arched design of this product provides the perfect backdrop for the beautiful Regency fire. Glowing embers and realistic split logs are molded from real wood to create the appeal of an authentic looking wood burning fire.

SPECIFICATIONS (NATURAL GAS)*

Input (BTU)	35,000
Turn down to (BTU)	18,200
EnerGuide Rating (Canada only)	67.75%
Efficiency (steady state)	75%

DIMENSIONS

Viewing Area	455 sq.in.
Width	37"
Height	29-1/4"

* For propane (LP) specs please see page 20.
For detailed specifications please see pages 20-23.

STANDARD FEATURES

- Natural gas
- Ceramic glass
- Log set with embers
- Fire grate
- Black brick panel floor
- Blower
- Proflame remote control
- Flame height adjustment control
- Limited lifetime warranty

OPTIONS

- Arch surround in black with integrated safety screen
- Brick panels in various colors and designs
- Double door inlay
- Accent kits in polished gold or polished nickel for double door inlay & arch surround
- Wall thermostat
- Propane conversion kit
- Heat Wave™ power duct kit
- Heat Release™ kit
- AstroCap® venting system



Liberty L965E shown with castlestone brick panels and integrated safety screen.

LIBERTY® LARGE GAS FIREPLACE | L965E

ELEGANT STYLE, CONTROLLABLE HEAT

Creating an elegant focal point with Regency Liberty® L965E one of the largest viewing areas available in the Regency line. The L965E permits finish materials to be installed to the edges for a pure, unadorned appearance. An adjustable burner system allows the flame to be controlled for mood and comfort from a roaring fire to a gentle glow all from the convenience of a hand-held remote control.

SPECIFICATIONS (NATURAL GAS)*

Input (BTU)	48,000
Turn down to (BTU)	16,000
EnerGuide Rating (Canada only)	63%
Efficiency (steady state)	79%

DIMENSIONS

Viewing Area	965 sq.in.
Width	36-13/16"
Height	33-1/4"
Depth	24"

* For propane (LP) specs please see page 20.
For detailed specifications please see pages 20-23.

STANDARD FEATURES

- Natural gas
- Safety screen
- Ceramic glass
- Log set with embers
- Fire grate
- Accent lights
- Flame height adjustment control
- Proflame remote control
- Electronic ignition with SureFire™ switch
- Two stage burner
- Limited lifetime warranty

OPTIONS

- Brick panels in a variety of colors and designs
- Inner reflective panels in black enamel
- Propane conversion kit
- Vertical or horizontal vent terminations
- Heat distribution kit
- AstroCap® venting system

DESIGN CHOICES - TRADITIONAL COLLECTION

CLEAN FACE TRADITIONAL FIREPLACES



P33CE



B36XTCE



B41XTCE



L965E

SURROUND OPTIONS

VERONA METAL SURROUNDS



P33CE

VERONA GLASS SURROUNDS



P33CE

Finishes

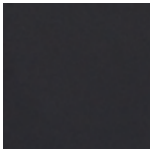

Black



Stainless Steel

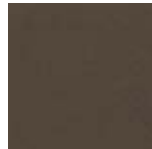

Sunset Bronze

Finishes



Chocolate Brown



Pure Black

INNER PANEL OPTIONS



Herringbone - Rustic Brown



Standard - Rustic Brown



Standard - Old Town Red



Standard - Charcoal



Castlestone



Ledgestone



Black Enamel Panels



Ember upgrade package

VIGNETTE & LOUVERED TRADITIONAL FIREPLACES



P33/P33E



P36/P36E/P36D



B36XTE



B41XTE

VIGNETTE FACEPLATE OR LOUVERED OPTIONS

VIGNETTE FACEPLATES & DOOR INLAY



Shown with black Vignette Faceplate,
Tuscan Sunset Door Inlay & Vignette finishing trim.

- ① Vignette Faceplate
- ② Vignette Inlay

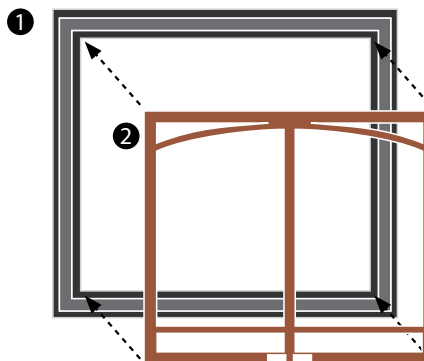

VIGNETTE FACEPLATES & INLAYS FINISHES



Black



Black Chrome



Platinum
(Not available for inlays)



Tuscan Sunset

LOUVERS



Black Louvers



Flush Panels

OPTIONS

ACCESSORIES - AT A GLANCE		L965E	B41XTCE	B41XTE	B36XTCE	B36XTE	P90	P36/ P36D	P36E	P33CE	P33E	P33	P131	P121	
Clean front	Glass	✓	✓	•	✓	•	•	•	•	✓	•	•	•	•	
Faceplates	Vignette	Black	•	•	★	•	★	•	★	★	•	★	★	•	•
		Black Chrome	•	•	★	•	★	•	★	★	•	★	★	•	•
		Platinum	•	•	★	•	★	•	★	★	•	★	★	•	•
		Tuscan Sunset	•	•	★	•	★	•	★	★	•	★	★	•	•
	Vignette Door Inlay	Black	•	•	★	•	★	•	★	★	•	★	★	•	•
		Black Chrome	•	•	★	•	★	•	★	★	•	★	★	•	•
		Tuscan Sunset	•	•	★	•	★	•	★	★	•	★	★	•	•
Vignette Finishing trim	•	•	★	•	★	•	★	★	•	★	★	•	•		
Surrounds	Metal	Black	•	•	•	•	•	•	•	★	•	•	•	•	
		Stainless Steel	•	•	•	•	•	•	•	•	★	•	•	•	
		Sunset Bronze	•	•	•	•	•	•	•	•	★	•	•	•	
	Glass	Pure Black	•	•	•	•	•	•	•	•	★	•	•	•	
		Chocolate	•	•	•	•	•	•	•	•	★	•	•	•	
Excalibur Arch Surrounds	Surround	•	•	•	•	•	★	•	•	•	•	•	•	•	
	Door Inlay	•	•	•	•	•	★	•	•	•	•	•	•	•	
Classic look	Louvers	•	•	•	•	•	•	★	★	•	★	★	★	★	
	Flush panels	•	•	★	•	★	•	•	•	•	•	•	•	•	
	Finishing Trim	•	•	★	•	★	•	★	★	•	★	★	•	★	
Inner panels	Bricks	Standard - Rustic Brown	•	★	★	★	★	★	★	★	★	★	★	•	•
		Standard - Old Town Red	★	★	★	★	★	★	★	★	★	★	★	✓	✓
		Standard - Charcoal	•	★	★	•	•	•	•	•	•	•	•	•	•
		Herringbone - Rustic Brown	•	•	•	•	•	★	★	★	★	★	★	•	•
		Castlestone	★	★	★	★	★	•	•	•	•	•	•	•	•
	Ledgestone	★	•	•	•	•	•	•	•	•	•	•	•	•	
Reflective	Black enamel	★	★	★	★	★	•	★	★	★	★	★	•	•	
Safety Screen*		✓	✓	✓	✓	✓	✓	✓	✓	✓	✓	✓	✓	✓	
Ember upgrade package		•	★	★	★	★	★	★	★	★	★	★	★	★	
Blower (with fan speed controller)		•	★	★	★	★	✓	★	★	★	★	★	•	•	
Blower (1-speed wall switch)		•	•	•	•	•	•	•	•	•	•	•	✓	✓	
Controls	Programmable Thermostat	•	★	★	★	★	★	★	★	★	★	★	★	★	
	Proflame GTMF Remote Control	•	✓	✓	✓	✓	✓	✓	✓	✓	✓	✓	✓	✓	
	Proflame GTMFS Remote Control	✓	•	•	•	•	•	•	•	•	•	•	•	•	
Electronic ignition with Surefire™ switch		✓	✓	✓	✓	✓	•	•	✓	✓	✓	•	•	•	
Venting	Direct vent	✓	✓	✓	✓	✓	✓	✓	✓	✓	✓	✓	✓	✓	
	AstroCap® Venting System	★	★	★	★	★	★	★	★	★	★	★	★	★	
	Heat Wave™ Power Duct System	•	•	•	•	•	★	★	★	★	★	★	•	•	
	Heat Release™ Kit	•	•	•	•	•	★	★	★	•	•	•	•	•	
Heat Distribution kit	★	•	•	•	•	•	•	•	•	•	•	•	•		
Propane conversion kit		★	•	•	★	★	★	★	★	★	★	★	★	★	

• Not available

✓ Standard

★ Optional

* Safety screen is included with unit or faceplate

REMOTES & THERMOSTATS



Proflame GTMF Remote Control
(Standard)



Programmable Thermostat
(Optional)

FEATURE	DESCRIPTION	PROFLAME GTMF	PROGRAMMABLE THERMOSTAT
On/Off		✓	✓
Child lock		✓	•
LCD Backlit Screen		✓	✓
Clock		•	✓
Temperature display	°F / °C	✓	✓
Thermostat	one setting (very day)	✓	✓
	5-day day weekday & 2-day weekend	•	✓
Smart thermostat*		✓	•
Flame adjustment	(6 levels)	✓	•
Fan control**	(6 levels)	✓	•
Accent light (On/Off)***		✓	•

* Smart Thermostat - Rather than a thermostat that simply turns your fireplace on and off, the Smart Control function allows you to set your desired room temperature. As the room reaches your personal setting the flame intensity and heat will gradually decrease - keeping the ambience of your Regency fire on with less heat output with the option to turn off at any time.

** For models that have a blower.

*** For models that have an optional accent light.

NO CHIMNEY? NO PROBLEM!

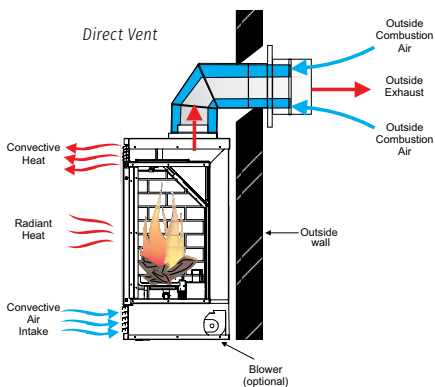

Direct Vent Technology allows you to add a fireplace to rooms with no existing chimney. Simply vent your fireplace through an outside wall and finish it with the patented Regency AstroCap Flex Venting System.

Maintain your indoor air quality by drawing fresh combustion air from outside through the venting system in to a sealed firebox. The exhaust is returned outdoors without affecting your indoor air. Direct Vent Technology is crucial in maintaining both high efficiency and indoor air quality.

SPREAD THE WARMTH

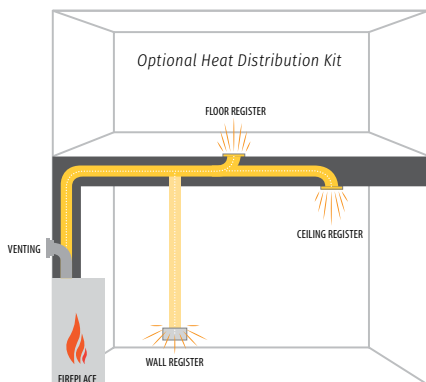

Zone Heating with Regency: By adding a fireplace to your most frequently used living space you're not wasting energy by heating rooms you don't use.

Heat Adjacent Rooms with the Heat Wave™ - Power Duct System: Cut down on your heating costs using a Heat Wave kit. The Heat Wave system attaches onto most Regency gas fireplaces allowing you to direct heat into rooms up to 20 feet away. This kit comes complete with vent, variable speed blower (for HeatWave system only) and vent register.

MAXIMIZING COMFORT AND EFFICIENCY

Regency Fireplaces delivers controllable heating solutions by combining the latest in radiant/convection heat technology and innovative features.

- ☑ Adjustable flame/heat control
- ☑ Heat radiating ceramic glass
- ☑ SureFire Electronic Ignition switch with battery backup features a fuel saving intermittent pilot ignition conserving energy when not in use.

- ☑ Power's Out, Heat's On. All Regency gas fireplaces operate without electricity. Enjoy peace of mind all winter long.

- ☑ Variable speed blower to maximize efficiency. Our quiet blowers increase the efficiency of your fireplace by pushing the heat produced by your fireplace forward and distributing it further and evenly into the room.

- ☑ Proflame GTMF Remote Control. A standard feature included with all Traditional Gas Fireplaces, this user friendly programmable remote can be set to start your Regency fire at your desired room temperature and be easily adjusted with the touch of a button.

SPECIFICATIONS

SPECIFICATIONS		INPUT (BTU)		TURN DOWN TO (BTU)		ENERGUIDE RATING (CANADA ONLY)		EFFICIENCY (STEADY STATE)	
		NG	LP	NG	LP	NG	LP	NG	LP
Liberty	L965E	48,000	48,000	16,000	17,000	63.11%	63.46%	79%	79%
Bellavista	B41XTCE	42,500	37,500	30,000	29,500	68.59%	68.97%	73%	73%
	B41XTE	42,500	37,500	30,000	29,500	68.59%	68.97%	73%	73%
	B36XTE	31,000	31,000	21,500	25,000	66.47%	65.59%	71%	71%
	B36XTCE	31,000	31,000	21,500	25,000	66.50%	66.59%	71%	71%
Panorama	P131	40,000	39,000	20,500	20,600	60.66%	62.51%	75%	75%
	P121	40,000	39,000	20,500	20,600	60.66%	62.51%	75%	75%
	P36D	30,000	30,000	15,500	15,000	64.62%	64.62%	82%	82%
	P36	30,000	30,000	15,500	15,000	62.70%	62.70%	82%	82%
	P36E	29,500	28,500	19,500	22,000	67.45%	68.40%	82%	82%
	P33	20,000	18,000	14,000	14,500	65.50%	68.24%	76%	77%
	P33E	20,000	19,500	14,000	15,500	67.41%	70.61%	76%	77%
	P33CE	20,000	19,500	14,000	15,500	67.41%	70.61%	76%	77%
Excalibur	P90	35,000	35,000	18,200	17,950	67.75%	67.75%	75%	75%

P131 / P121 FRONT

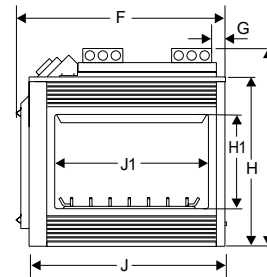

P131 SIDE

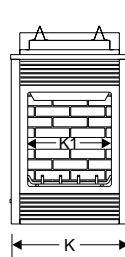

P131 BACK / P121 SIDE

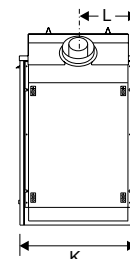

DIMENSIONS	P131	P121
F	44-1/2"	46-1/4"
G	3"	4-3/4"
H	36"	36"
H1	20"	20"
I	42"	42"
J	41-1/2"	43-1/2"
J1	32-5/8"	32-5/8"
K	25"	25"
K1	17-3/4"	--
L	12-1/2"	12-1/2"

Note: For P121 there is a 2-3/4" vent heat shield on the vent end of the fireplace. Please allow appropriate space for center positioning.

LIBERTY L965E

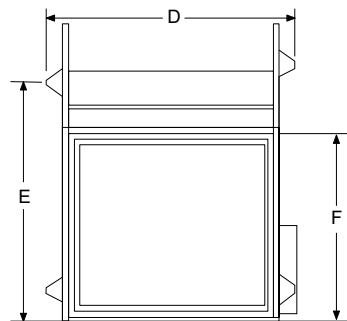
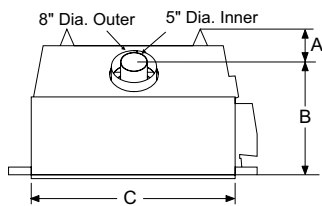

EXCALIBUR P90

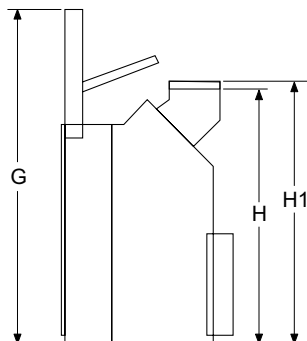
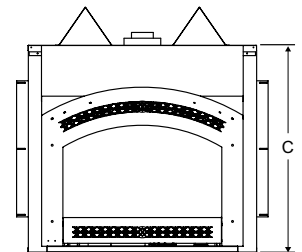
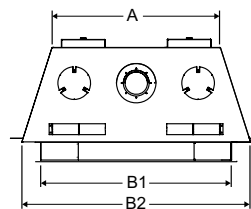

DIMENSIONS	L965E
A	5-1/4"
B	18-3/4"
C	36-13/16"
D	44-5/8"
E	43"
F	33-1/4"
G	52-5/16"
H	39-11/16"
H1	41-3/16"

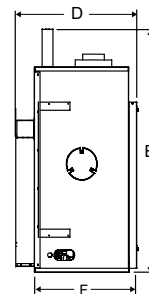

DIMENSIONS	P90
A	31"
B1	35-1/8"
B2	42"
C	38"
D*	22-1/2"
E	45"
F	18-3/4"

* Without faceplate

For installation, framing and clearances see manuals on our website: www.regency-fire.com

All products tested to the following standards: GRAVITY DIRECT VENT WALL FURNACE TESTED AND APPROVED FOR U.S.A AND CANADA TO: CAN/CGA-2.17-M91, (ANSI Z21.88b-1999/CSA 2.33b-M99). NOTE: All product specifications are subject to change without notice. Before installing refer to the relevant product manual for full and up to date information.

SPECIFICATIONS

PANORAMA DIRECT VENT FIREPLACES

P36D
P36E
P36

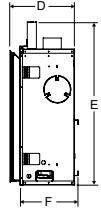
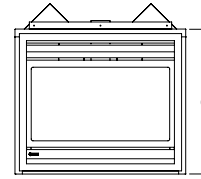
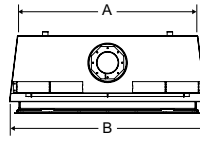

P33
P33E

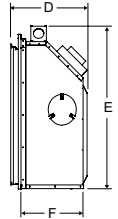
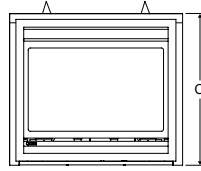
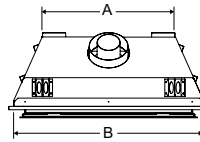

P33CE

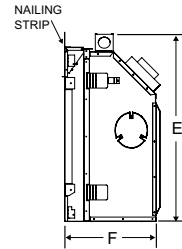
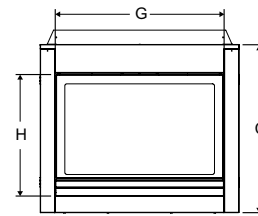
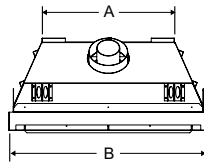

DIMENSIONS	P36D	P36E	P36	P33E/P33	P33CE
A	33-1/16"	33-1/8"	33-1/8"	23"	23"
B	36-1/16"	36-1/16"	36-1/16"	33"	34-9/16"
C	30-1/2"	30-1/2"	30-1/2"	29"	29-1/2"
D*	20-1/16"	15"	15"	14-3/4"	--
E	36"	36"	36"	31-1/2"	31-3/4"
F	17-7/8"	12-3/16"	12-3/16"	12-3/4"	16"
G	--	--	--	--	29-7/16"
H	--	--	--	--	21-3/8"

* Includes Vignette faceplate
See manual for Vignette finishing trim dimensions

BELLAVISTA DIRECT VENT FIREPLACES

B41XTE/
B36XTE

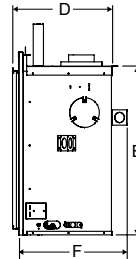
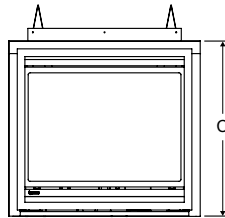
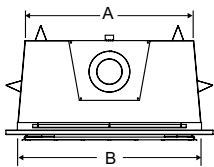

B41XTCE/
B36XTCE

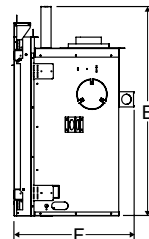
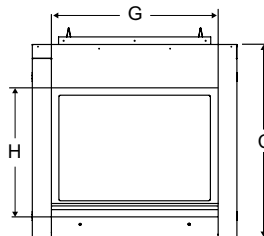
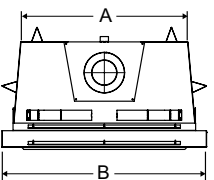

DIMENSIONS	B41XTE	B41XTCE	B36XTE	B36XTCE
A	38-3/8"	38-3/8"	33-1/16"	33-1/16"
B	41-11/16"	46-11/16"	36"	40-5/8"
C	36-11/16"	44-1/4"	35-1/4"	38-1/16"
D*	24-3/16"	--	22-1/2"	--
E	36-3/8"	49-1/4"	33-1/8"	41-5/16"
F	22-3/8"	26-3/16"	20-7/16"	23-5/8"
G	--	38-7/16"	--	32-7/8"
H	--	29-1/8"	--	25-5/8"

* Includes Vignette Faceplate

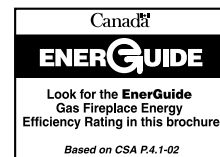

For installation, framing and clearances see manuals on our website: www.regency-fire.com

All products tested to the following standards: GRAVITY DIRECT VENT WALL FURNACE TESTED AND APPROVED FOR U.S.A AND CANADA TO: CAN/CGA-2.17-M91, (ANSI Z21.88b-1999/CSA 2.33b-M99).
NOTE: All product specifications are subject to change without notice. Before installing refer to the relevant product manual for full and up to date information.

FRAMING & INSTALLATION

P36/P36E/P36D

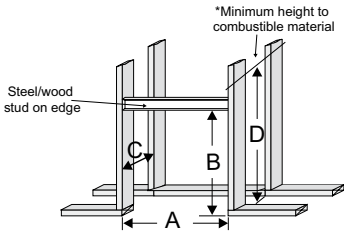

INSTALLATION	UNITS	A	B	C	D*	E	F	G	H	I	J
Framing with Vignette Faceplate	P36/P36E	36-1/4"	40-3/4"	12-3/4"	46"	42-7/16"	33-1/4"	36-1/4"	60"	7-1/4"	12-3/4"
	P36D	36-1/4"	40-3/4"	17-3/8"	46"	48"	33-1/4"	36-1/4"	68"	11-1/4"	17-1/8"
Framing with Vignette Faceplate & Finishing Trim Finished Flush	P36/P36E	38"	41-5/8"	14-3/4"	46"	43-11/16"	33-1/4"	38"	61-13/16"	9-1/4"	14-3/4"
	P36D	38"	41-5/8"	19-3/8"	46"	50-9/16"	33-1/4"	38"	71-9/16"	13-1/4"	-
Framing with Louvers and safety screen	P36/P36E	36-1/4"	36-1/4"	12-3/4"	46"	42-7/16"	33-1/4"	36-1/4"	60"	7-1/4"	12-3/4"
	P36D	36-1/4"	37-1/4"	17-3/8"	46"	48"	33-1/4"	36-1/4"	68"	11-1/4"	17-1/8"

* 'D' is minimum height to combustible materials including the minimum 2" top clearance to the horizontal vent.

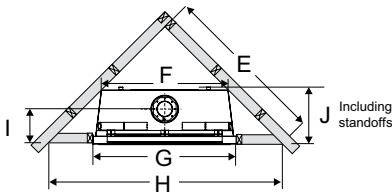

P90

INSTALLATION	UNIT	A	B	C	D	E	F	G	H	I	J
Framing and Finishing	P90	46-1/2"	45-1/4" 46-3/8**	21-1/2"	53-3/4"	51-1/8"	31"	46-1/2"	72-1/4"	13-11/16"	19-1/4"

** If raised 1-1/8" using base standoffs

P33/P33E

VERTICAL TERMINATION OR VERTICAL RISE WITH HORIZONTAL TERMINATION
Vignette and Vignette Finishing Trim - Finished Flush

For Both Rigid & Flex

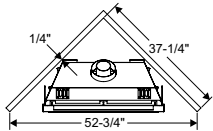
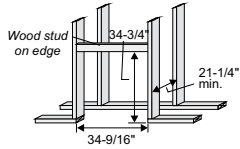

REAR TERMINATION

Vignette and Vignette Finishing Trim - Finished Flush

For Rigid Vent

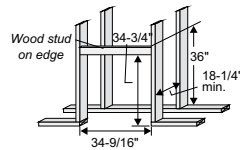

For Flex Vent

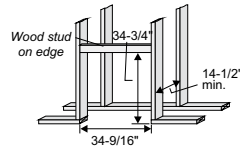

For Both Rigid & Flex

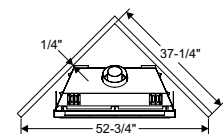

VERTICAL TERMINATION OR VERTICAL RISE WITH HORIZONTAL TERMINATION
Vignette and Vignette Finishing Trim or Safety Screen and Louvers

For Both Rigid & Flex

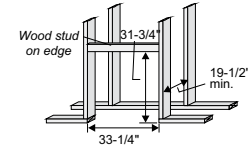

REAR TERMINATION

Vignette and Vignette Finishing Trim or Safety Screen and Louvers

For Rigid Vent

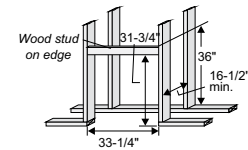

For Flex Vent

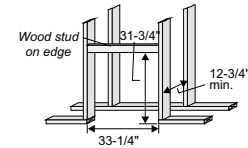

For Both Rigid & Flex

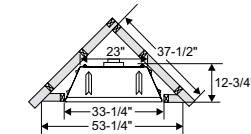

P121 - SEE THRU

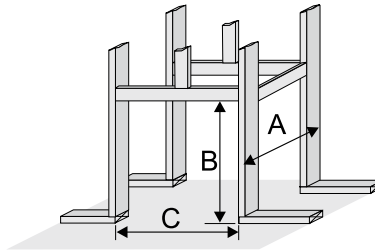

DIMENSIONS	P121
A*	25"
B	42-1/2"
C	46-3/4"

*Minus 2X the finishing material thickness. Finish Material thickness includes: drywall, ceramic tile, slate, etc.

NOTE: The appliance extends 2-3/4" further on the vent side. If trying to center the appliance in a room add 2-3/4" to the non vent side when framing. Do not however change dimension (C) as the opening remains the same.

P131 - PIER

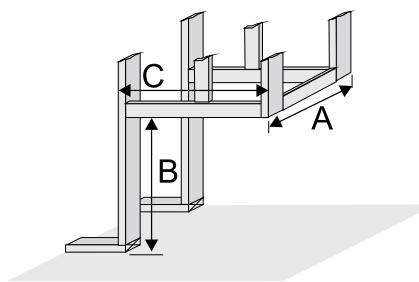

DIMENSIONS	P121
A*	25"
B	42-1/2"
C	45"

*Minus 1X the finishing material thickness. Finish Material thickness includes: drywall, ceramic tile, slate, etc.

For installation, framing and clearances see manuals on our website: www.regency-fire.com

All products tested to the following standards: GRAVITY DIRECT VENT WALL FURNACE TESTED AND APPROVED FOR U.S.A AND CANADA TO: CAN/CGA-2.17-M91, (ANSI Z21.88b-1999/CSA 2.33b-M99). NOTE: All product specifications are subject to change without notice. Before installing refer to the relevant product manual for full and up to date information.

FRAMING & INSTALLATION

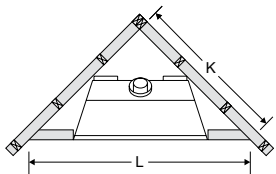
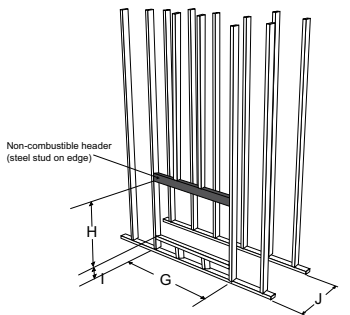
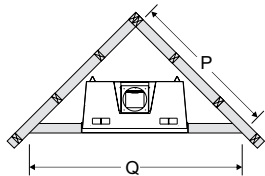
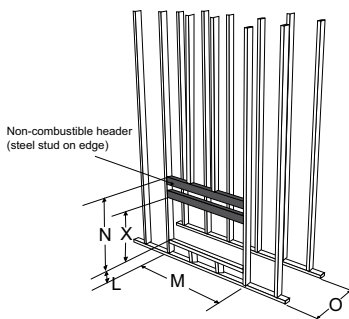
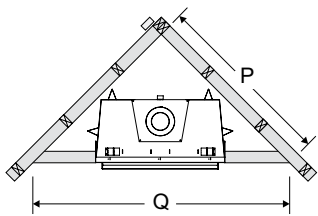
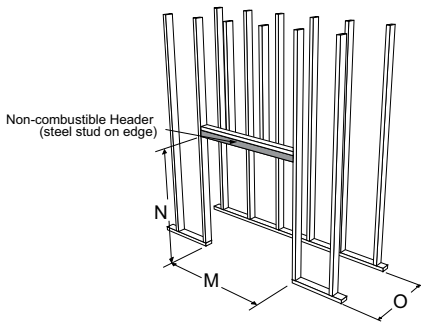

B36XTE/B41XTE

INSTALLATION	UNITS	M	N	O (REAR VENT)	O (TOP VENT)	P (REAR VENT)	P (TOP VENT)	Q (REAR VENT)	Q (TOP VENT)
Framing with Vignette (No Finishing Trim) or with flush panels and safety screen	B36XTE	40-5/8"	42"	20-3/4"	20-1/2"	53" - AstroCapXL 61-1/2" - other approved caps	48-5/8"	75" - AstroCapXL 87" - other approved caps	68-3/4"
	B41XTE	47-1/4"	49-1/2"	23-1/4"	22-5/8"	60-1/4"	-	85-3/16"	-
Framing with Vignette & Vignette Trim Finished Flush	B36XTE	42-1/4"	42"*	22-1/8"	21-7/8"	55-11/16" - AstroCapXL 64-3/16" - other approved caps	51-5/16"	78-3/4" - AstroCapXL 90-3/4" - other approved caps	72-1/2"
	B41XTE	48-15/15"	50-1/4"	24-7/8"	24-7/8"	63-3/8"	-	89-5/8"	-

* NOTE: When using the optional Vignette finishing trim, this can be installed as a 3-sided or 4-sided finish trim. If choosing to use this as a 4-sided finish trim the framing would need to be increased by 11/16" minimum in order for this to fit. This must be to the finished floor.

B41XTCE

INSTALLATION	M	N	O (REAR VENT)	O (TOP VENT)	P	Q
Framing	47-1/4"	49-1/2"	26-1/2"	25-7/8"	65-1/4"	91-11/16"

B36XTCE

FRAMING	B36XTCE
L	0"
M	41-1/4"
N	46-3/4"
O (Rear Vent)	23-7/8"
O (Top Vent)	23-7/8"
P (Rear Vent)	57-7/8" AstroCapXL 66-1/8" other approved caps
P (Top Vent)	53-1/4"
Q (Rear Vent)	81-1/2" AstroCapXL 93-1/2" other approved caps
Q (Top Vent)	75-1/4"

L965E

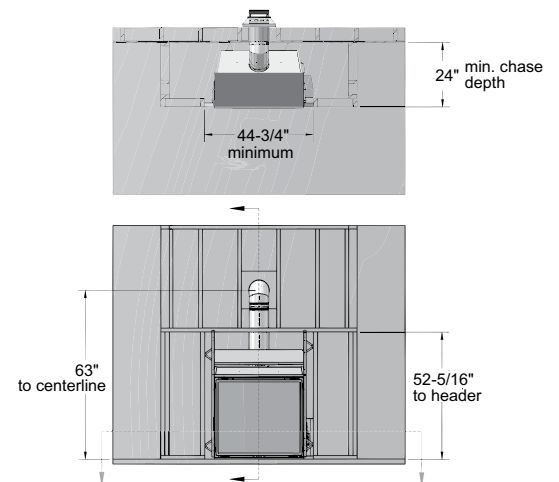

P33CE

FRAMING	P33CE WITH NON-COMBUSTIBLE BOARD ONLY	P33CE WITH TILE, STONE, BRICK, SLATE, MODERA MANTEL, VERONA SURROUND OR OTHER NON-COMBUSTIBLE FINISH
G	35"	35"
H	31-3/4"	31-3/4"
I	0" (when not using a surround/mantel)	0" 2" min (w/ modera mantel) 3-5/16" min (w/ verona surround)
J	23-1/4" Vertical Rise 16-1/2" Flex	22-3/4" Vertical Rise 19-3/4" Rigid/ 16" Flex
K	39-1/4"	38-15/16"
L	55-1/2"	54-1/2"

For installation, framing and clearances see manuals on our website: www.regency-fire.com

All products tested to the following standards: GRAVITY DIRECT VENT WALL FURNACE TESTED AND APPROVED FOR U.S.A AND CANADA TO: CAN/CGA-2.17-M91, (ANSI Z21.88b-1999/CSA 2.33b-M99).
NOTE: All product specifications are subject to change without notice. Before installing refer to the relevant product manual for full and up to date information.

FIREPLACE PLANNING MADE SIMPLE

Your Regency® matches your home and lifestyle perfectly. How do we know that? Because you designed it yourself!

www.regency-fire.com

1



CLICK!

Take a photo of your desired room location.

2



DESIGN

Go to www.regency-fire.com and design your perfect fireplace with the Fireplace Design Center.

3



VISUALIZE

Upload your room photo and see how the fireplace will look in your own home.

4



VISIT A REGENCY DEALER

Show your plan to one of our sales associates for expert advice. Your authorized Regency dealer will advise you on all the technical aspects and install your Regency.

5



NO CHIMNEY? NO PROBLEM!

Direct vent technology means you no longer need an expensive, elaborate chimney. Simply vent your fireplace through an outside wall and finish it with an AstroCap™.

6



ENJOY!

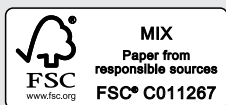

your Regency dealer

www.regency-fire.com

© 2016 FPI Fireplace Products International Ltd. Regency, Panorama, Excalibur, Bellavista, SureFire, Heat Wave, Heat Release, and AstroCap are registered or proprietary trademarks of FPI Fireplace Products International Ltd. All rights reserved. Printed in Canada (09/16) Part no. 944-227